

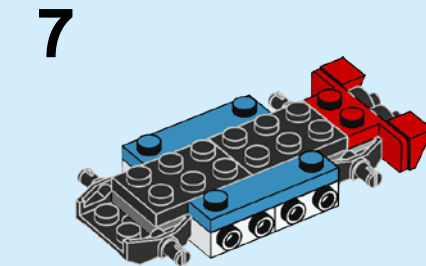

6268839

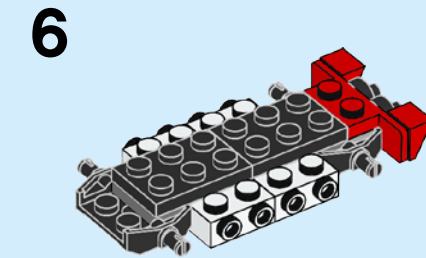
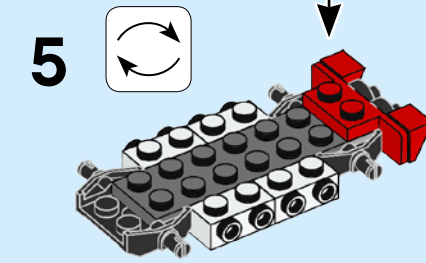
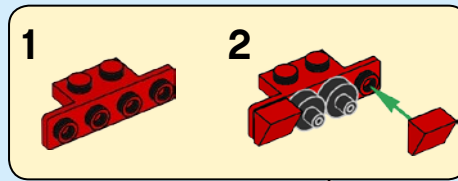
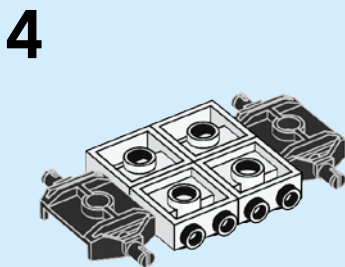
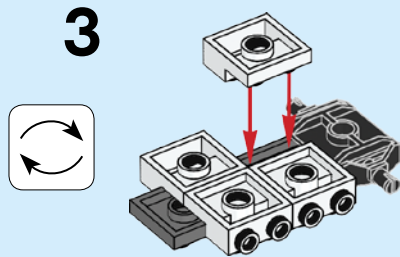
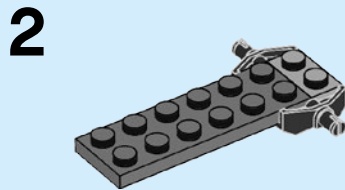

[LEGO.com/creator](http://LEGO.com/creator)

[LEGO.com/service](http://LEGO.com/service)

LEGO and the LEGO logo are trademarks of the LEGO Group.  
©2019 The LEGO Group. 6268839

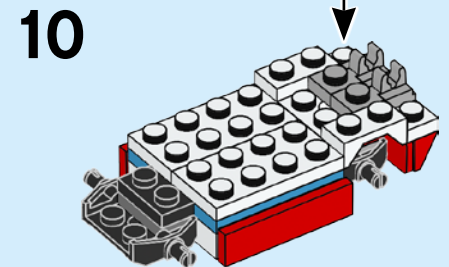
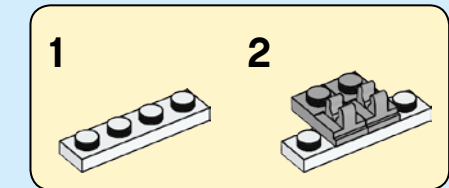
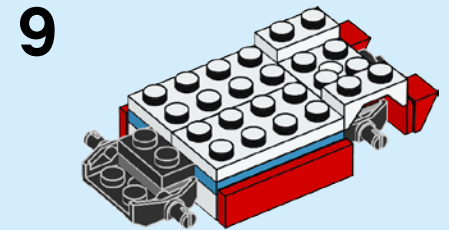
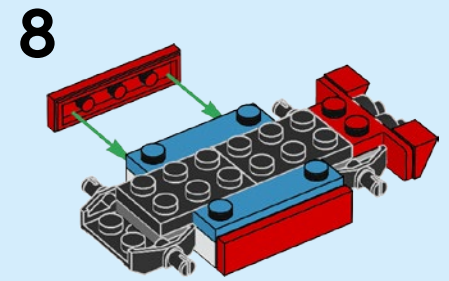

11

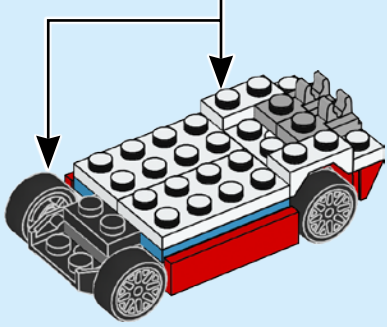
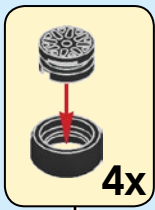

13

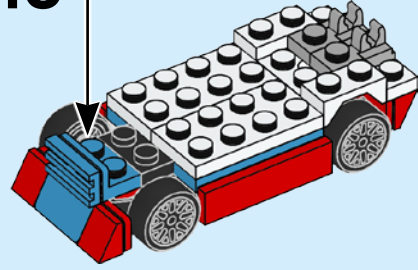
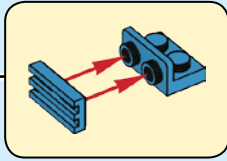

14

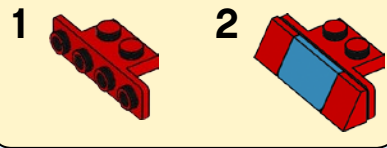
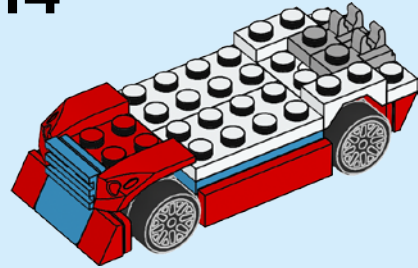

12

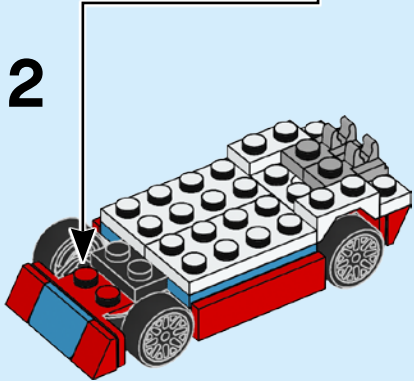

15

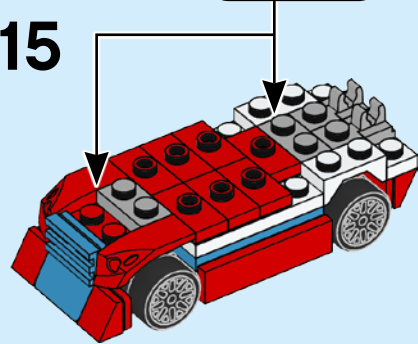
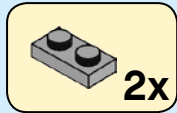

16

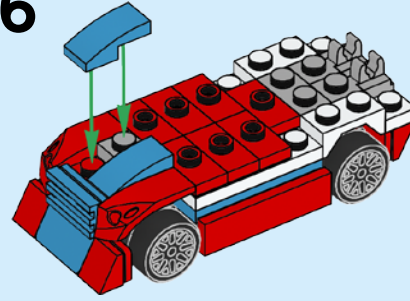

17

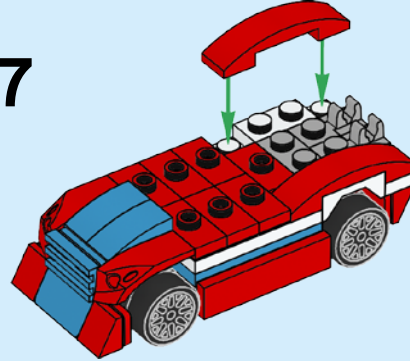

18

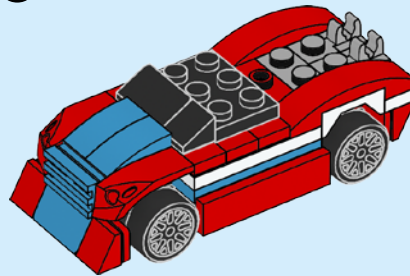

19

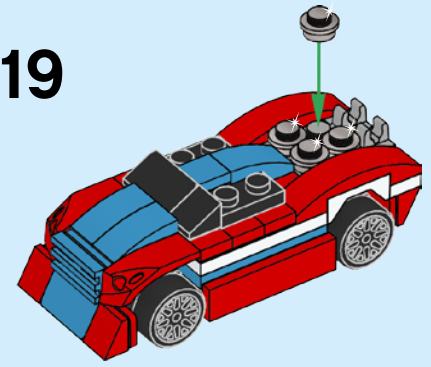

20

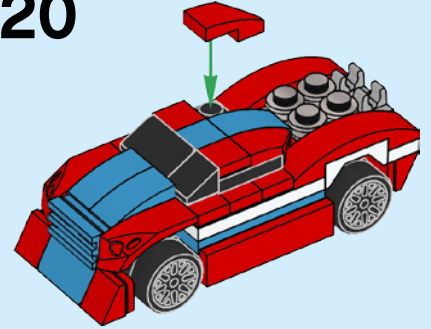

21

